

Integrated Tokamak Code: TASK

A. Fukuyama

Department of Nuclear Engineering, Kyoto University

Acknowledgments

M. Honda, H. Nuga, and BPSI working group

Outline

- 1. Integrated Simulation of Fusion Plasmas**
- 2. Integrated Tokamak Modeling Code: TASK**
- 3. Transport Modeling**
- 4. Source Modeling**
- 5. ITER Modeling**
- 6. Summary**

Integrated Simulation of Toroidal Plasmas

- **Why needed?**

- To predict the behavior of burning plasmas in tokamaks
- To develop reliable and efficient schemes to control them

- **What is needed?**

- **Simulation describing:**

- **Whole plasma** (core & edge & divertor & wall-plasma)
- **Whole discharge**
(startup & sustainment & transients events & termination)
- **Reasonable accuracy** (validation by experiments)
- **Reasonable computer resources** (still limited)

- **How can we do?**

- Gradual increase of understanding and accuracy
- Organized development of simulation system

Simulation of Tokamak Plasmas

Broad range of time scale:
100GHz ~ 1000s

Broad range of Spatial scale:
10 μm ~ 10m

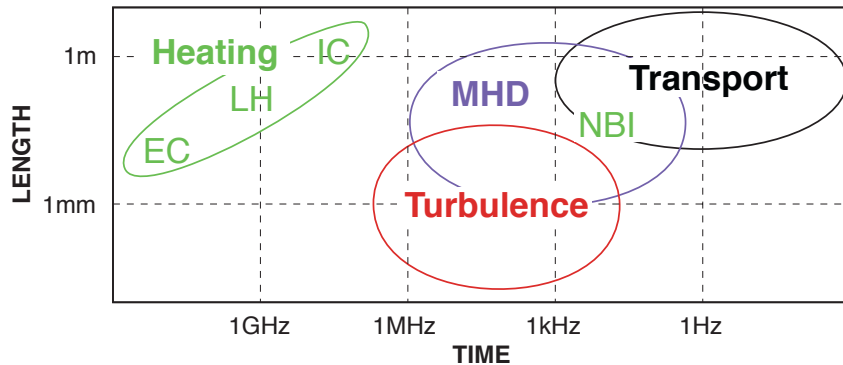

One simulation code never covers all range.

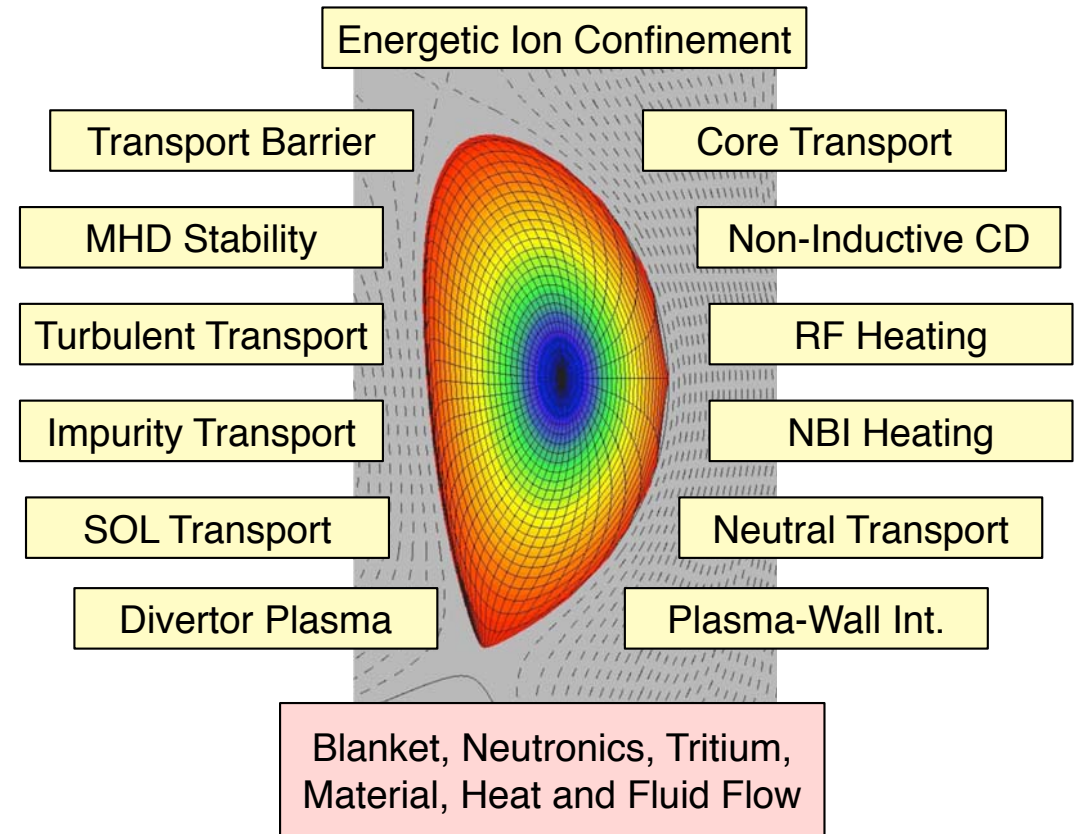

Integrated simulation combining modeling codes interacting each other

Integrated Tokamak Simulation

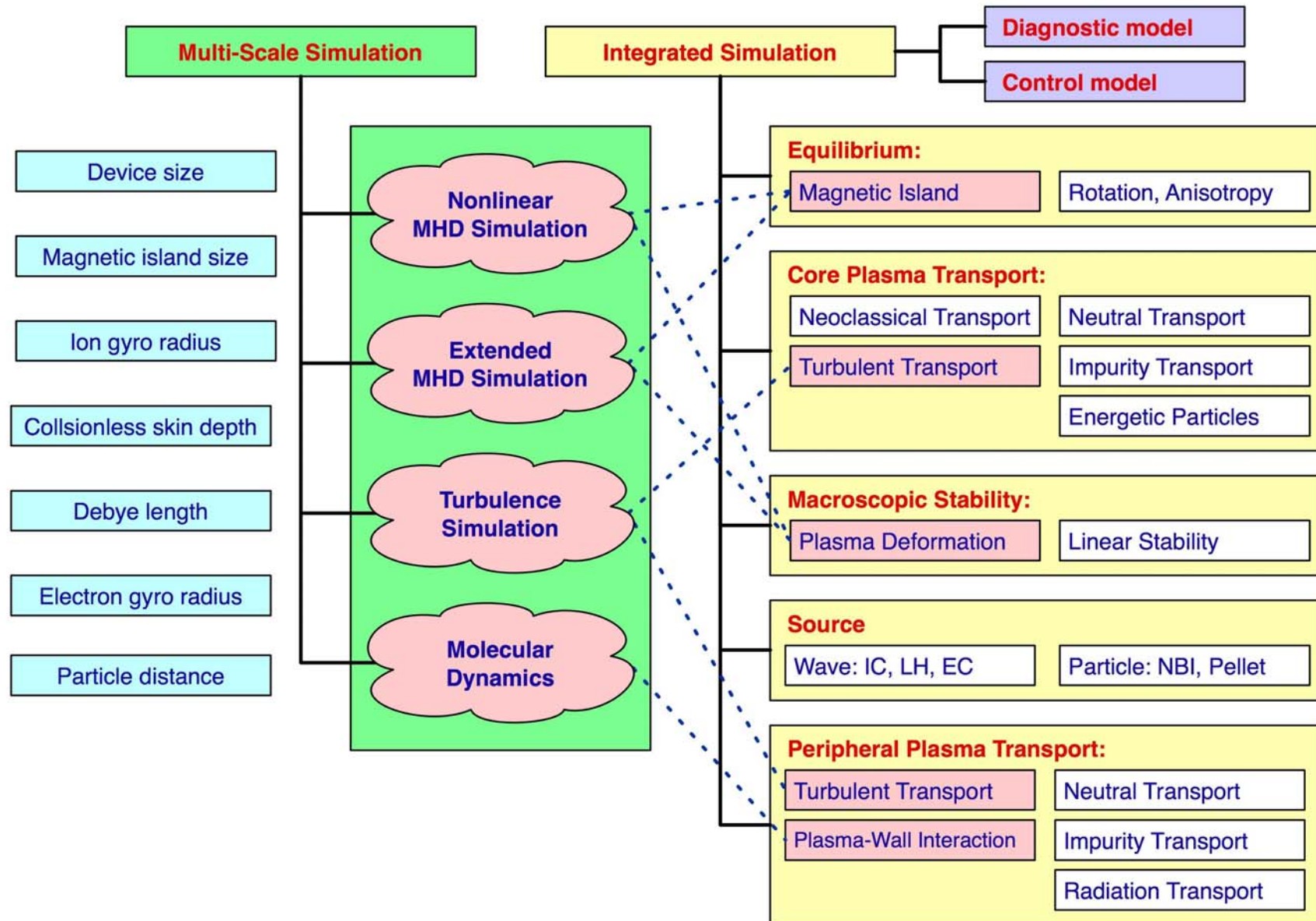

Desired Features of Integrated Modeling Code

- **Modular structure**: for flexible extension of analyses
 - **Core modules** (equilibrium, transport, source, stability)
 - **Various levels of models** (quick, standard, precise, rigorous)
 - **New physics models** (easier development)
- **Standard module interface**: for efficient development-of modules
- **Interface with experimental data**: for validating physics models
- **Unified user interface**: for user-friendly environment
- **Scalability in parallel processing** of time consuming modules
- **High portability**
- **Open source** of core modules
- **Visualization** included

Integrated Modeling Activities

- **Japan: BPSI** (Burning Plasma Simulation Initiative)
 - Research collaboration among universities, NIFS and JAEA
 - Framework for code integration
 - Physics integration
 - Advanced computing technology
- **EU: ITM-TF** (EFDA Task Force: Integrated Transport Modeling)
 - Code Platform Project: code interface, data structure
 - Data Coordination Project: verification and validation
 - Five Integrated Modeling Projects: EQ, MHD, TR, Turb., Source
- **US: FSP** (Fusion simulation project) — a part of SciDAC
 - Simulation of Wave Interactions with Magnetohydrodynamics (SWIM)
 - Center for Plasma Edge Simulation (CPES)
 - Framework Application for Core-Edge Transport Simulations (FACETS)
- **ITER: IMEG** (Integrated Modeling Expert Group)

BPSI: Burning Plasma Simulation Initiative

Research Collaboration of Universities, NIFS and JAEA

- **Targets of BPSI**

- **Framework** for collaboration of various plasma simulation codes
- **Physics integration** with different time and space scales
- **Advanced technique** of computer science

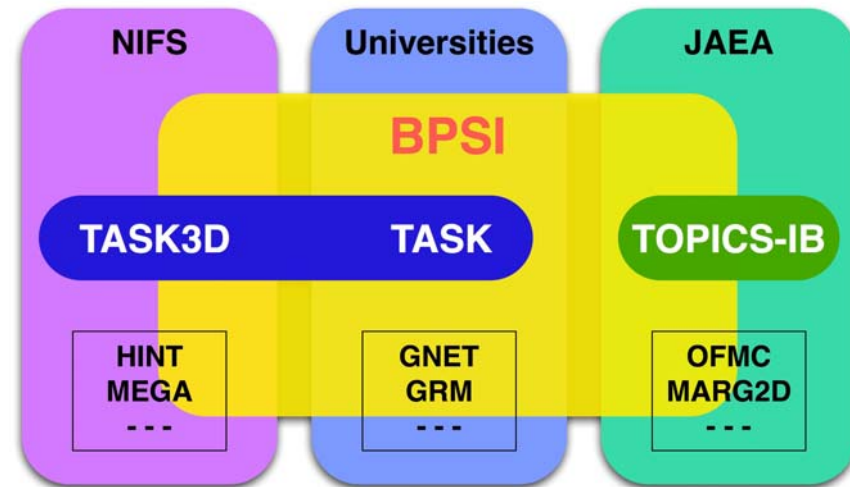
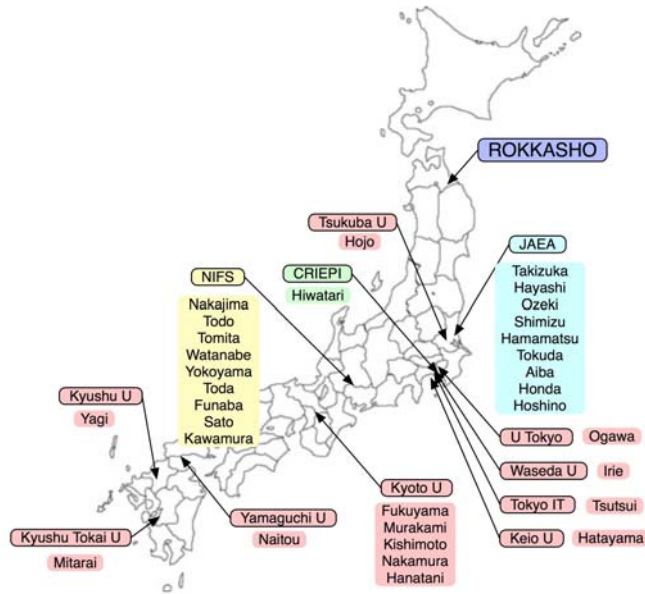

All Japan collaboration

Integrated code development

Integrated Modeling Code: TASK

- **Transport Analysing System for Tokamak**
- **Features**
 - **Core of Integrated Modeling Code in BPSI**
 - Modular structure
 - Reference implementation of standard data set and interface
 - **Various Heating and Current Drive Scheme**
 - EC, LH, IC, AW, NB
 - **High Portability**
 - Most of library routines included (except LAPACK, MPI, MDS+)
 - Original graphic libraries (X11, Postscript, OpenGL)
 - **Development using CVS** (Version control)
 - **Open Source:** <http://bps.nucleng.kyoto-u.ac.jp/task/>
 - **Parallel Processing using MPI Library** (partially)

Components of the TASK Code

- Developed since 1992, now in Kyoto University

BPSD	Data Exchange	Standard data set, Program interface
EQ	2D Equilibrium	Fixed boundary, Toroidal rotation
TR	1D Transport	Diffusive transport, Transport models
TX	1D Transport	Dynamic Transport, Rotation and E_r
FP	3D Fokker-Planck	Relativistic, Bounce-averaged
WR	3D Ray Tracing	EC, LH: Ray tracing, Beam tracing
WM	3D Full Wave	IC: Antenna excite, Alfvén Eigenmode
DP	Wave Dispersion	Dielectric tensor, Arbitrary $f(v)$
FIT3D	NBI Physics	Birth, Orbit width, Deposition
PL	Utilities	Interface to BPSD and profile database
LIB	Libraries	Common libraries, MTX, MPI
GSAF	Graphics	Original graphic library for Fortran

- **TASK3D**: Extension to 3D Helical Plasmas (**NIFS and Kyoto U**)

Original Structure of the TASK code

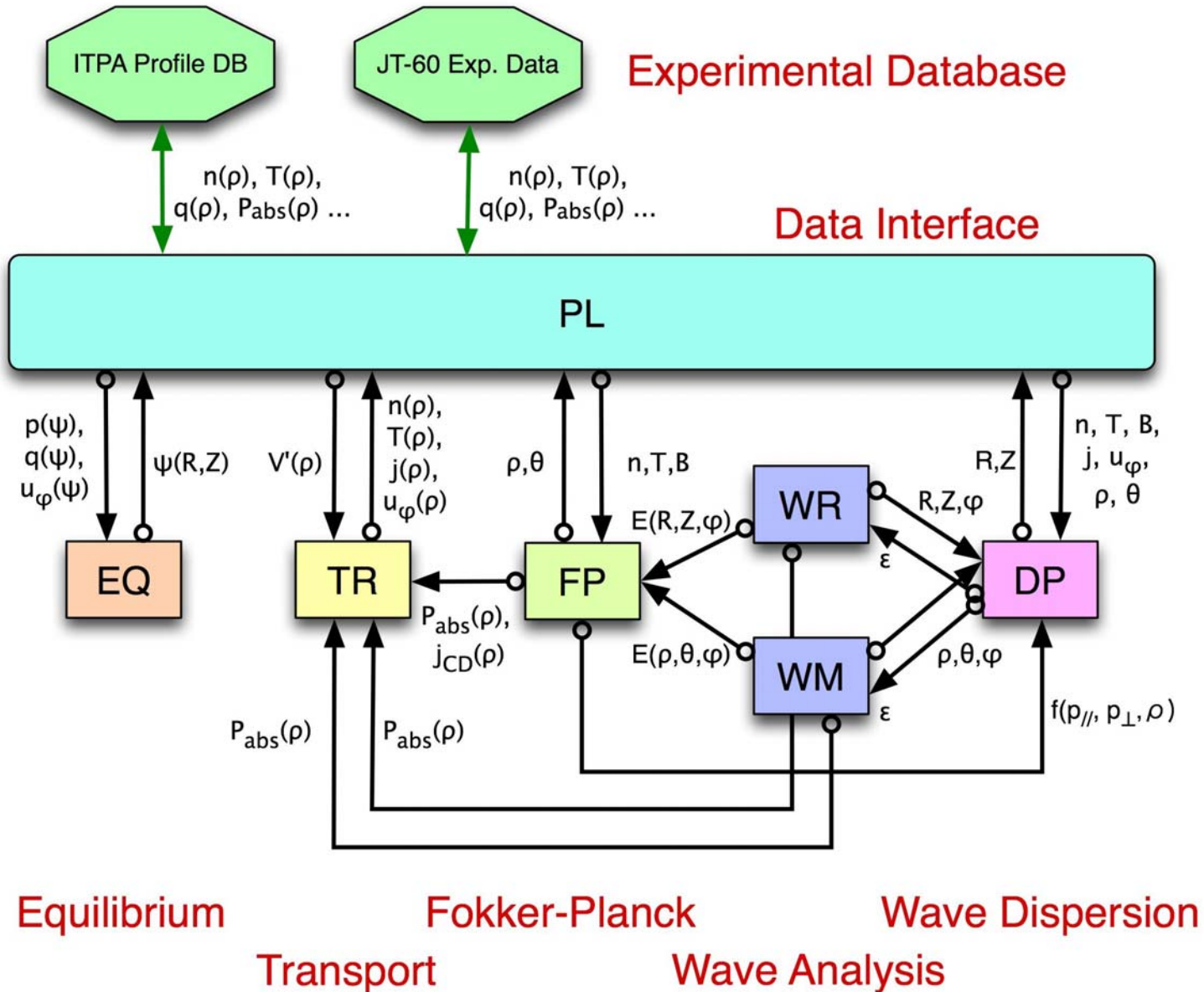

Present Structure of TASK and Related Codes in BPSI

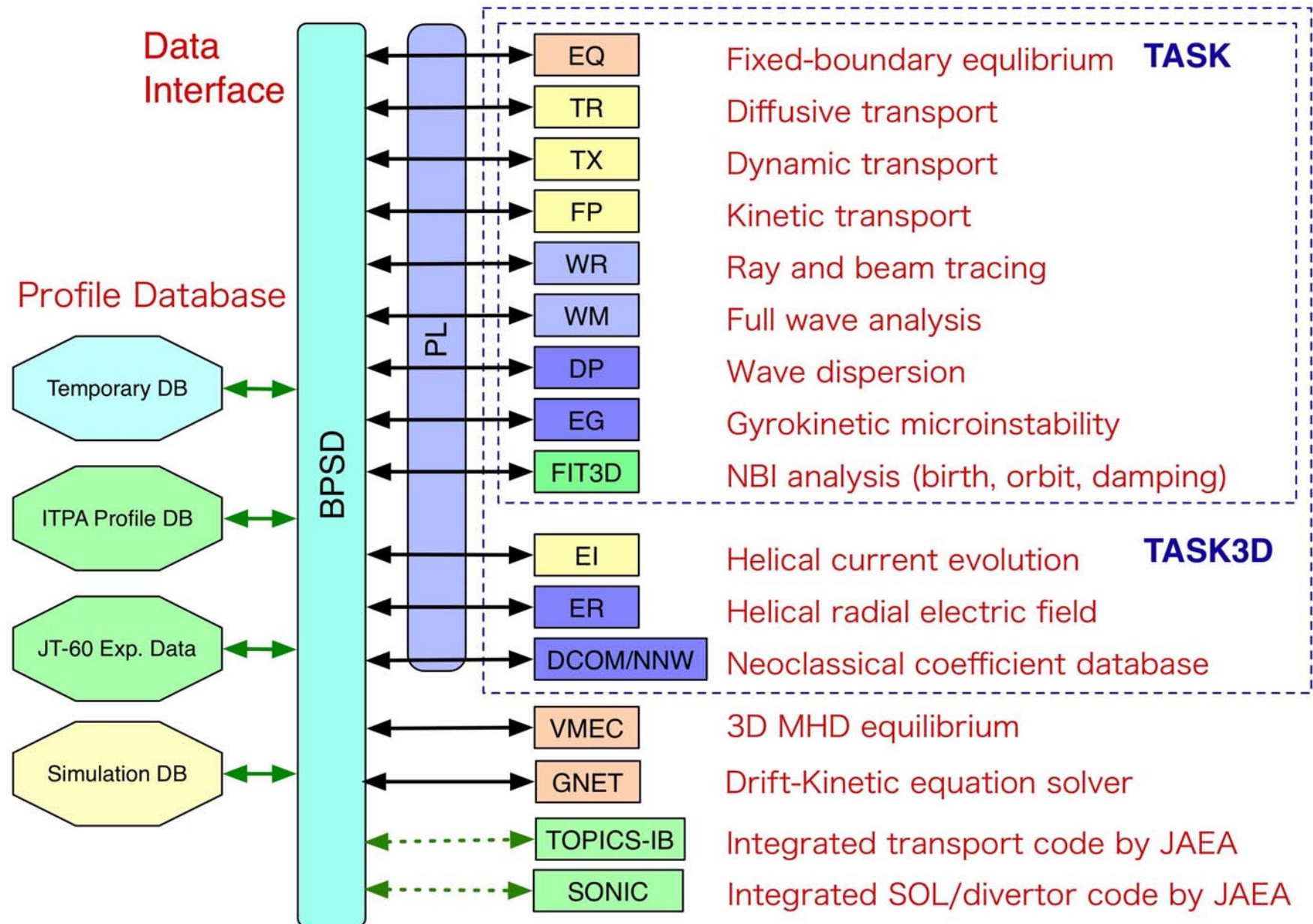

Inter-Module Collaboration Interface

- **Role of Module Interface**

- **Data exchange between modules: BPSD**

- **Standard dataset**: Specify set of data
- **Specification of data exchange interface**: set/get/load/save

- **Execution control: BPSX**

- **Specification of execution control interface**:
initialize, setup, exec, visualize, terminate
- **Uniform user interface**: parameter input, graphic output

- **Role of data exchange interface**

- **Keep present status of plasma and device**
- **Save into file and load from file**
- **Store history of plasma**
- **Interface to experimental data base**

Policies of BPSD

- **Minimum and Sufficient Dataset**
 - **To minimize the data to be exchanged**
 - **Mainly profile data**
 - **Routines to calculate global integrated quantities**
 - separately provided
- **Minimum Arguments in Interfaces**
 - **To maximize flexibility**
 - **Use derived data type or struct**
 - **Only one dataset in the arguments of an interface**
- **Minimum Interfaces**
 - **To make modular programming easier**
 - **Use function overloading**

Data Exchange Interface: BPSD

- **Standard dataset:** Specify data to be stored and exchanged
 - **Data structure:** Derived type (Fortran95): structured type

e.g.	time	<code>plasmaf%time</code>
	number of grid	<code>plasmaf%nrmax</code>
	number of species	<code>plasmaf%nsmax</code>
	square of grid radius	<code>plasmaf%s(nr)</code>
	plasma density	<code>plasmaf%data(nr,ns)%pn</code>
	plasma temperature	<code>plasmaf%data(nr,ns)%pt</code>

- **Specification of API:**
 - **Program interface**

e.g.	Set data	<code>bpsd_set_data(plasmaf,ierr)</code>
	Get data	<code>bpsd_get_data(plasmaf,ierr)</code>
	Save data	<code>bpsd_save(ierr)</code>
	Load data	<code>bpsd_load(ierr)</code>

BPSD Standard Dataset (version 0.6)

Category	Name	EQ	TR	TX	FP	WR	WM	DP
Shot data	bpsd_shot_type	–	–	–	–	–	–	–
Device data	bpsd_device_type	in	in	in	in			
1D equilibrium data	bpsd_equ1D_type	out	in	in	in			
2D equilibrium data	bpsd_equ2D_type	out			in	in	in	in
1D metric data	bpsd_metric1D_type	out	in	in	in			
2D metric data	bpsd_metric2D_type	out			in	in	in	in
Plasma species data	bpsd_species_type	in	in	in	in			in
Fluid plasma data	bpsd_plasmaf_type	in	out	out	i/o			in
Kinetic plasma data	bpsd_plasmak_type				out			in
Transport matrix data	bpsd_trmatrix_type		i/o					
Transport source data	bpsd_trsource_type		i/o	i/o	i/o	out	out	
Dielectric tensor data	bpsd_dielectric_type					in	in	out
Full wave field data	bpsd_wavef_type				in	out		
Ray tracing field data	bpsd_waver_type				in		out	
Beam tracing field data	bpsd_waveb_type				in		out	
User defined data	bpsd_0/1/2ddata_type	–	–	–	–	–	–	–

Execution Control Interface

- **BPSX**: not yet decided
 - **Monolithic integrated code**
 - **Script-driven element codes**
 - **MPI-2 driven element codes**

- **Example of element codes for TASK/TR**

TR_INIT	Initialization (Default value)
TR_PARM(ID, PSTR)	Parameter setup (Namelist input)
TR_SETUP(T)	Profile setup (Spatial profile, Time)
TR_EXEC(DT)	Exec one step (Time step)
TR_GOUT(PSTR)	Plot data (Plot command)
TR_SAVE	Save data in file
TR_LOAD	load data from file
TR_TERM	Termination

Equilibrium Analysis

- **Shape of an axisymmetric plasma:** poloidal magnetic flux $\psi(R, Z)$
- **Grad-Shafranov equation**

$$R \frac{\partial}{\partial R} \left(\frac{1}{R} \frac{\partial \psi}{\partial R} \right) + \frac{\partial^2 \psi}{\partial Z^2} = -\mu_0 R^2 \frac{dp(\psi)}{d\psi} - F(\psi) \frac{dF(\psi)}{d\psi}$$

- **Pressure profile:** $p(\psi)$
- **Poloidal current density profile:** $F(\psi)$
- **Plasma boundary shape** (fixed boundary) or **Poloidal coil current** (free boundary)

determines the poloidal plasma shape.

- **Coupling with transport analysis**

- **Input:** $p(\psi), q(\psi) = F \frac{dV}{d\psi} \left\langle \frac{1}{R^2} \right\rangle$
- **Output:** Metric quantities, Flux surface averaged quantities

Various Levels of Transport Modeling

Fluid model

Diffusive transport equation

$$n(\rho, t), T(\rho, t)$$

TR

Dynamic transport equation

$$n(\rho, t), \mathbf{u}(\rho, t), T(\rho, t), \mathbf{q}(\rho, t)$$

TX

Kinetic model

Bounce-averaged gyrokinetic equation

$$f(\rho, \theta_p, \rho, t)$$

FP

Axisymmetric gyrokinetic equation

$$f(\rho, \theta_p, \rho, \chi, t)$$

Gyrokinetic equation

$$f(\rho, \theta_p, \rho, \chi, \zeta, t)$$

Full kinetic equation

$$f(\rho, \theta_p, \phi_g, \rho, \chi, \zeta, t)$$

Transport Modeling in the TASK code

- **Diffusive transport equation: TASK/TR**
 - Diffusion equation for plasma density
 - Flux-Gradient relation
 - Conventional transport analysis
- **Dynamical transport equation: TASK/TX:**
 - Continuity equation and equation of motion for plasma density
 - Flux-averaged fluid equation
 - Plasma rotation and transient phenomena
- **Kinetic transport equation: TASK/FP:**
 - Gyrokinetic equation for momentum distribution function
 - Bounce-averaged Fokker-Plank equation
 - Modification of momentum distribution

Diffusive Transport Equation: TASK/TR

- **Transport Equation Based on Gradient-Flux Relation:**

$$\Gamma = \overleftrightarrow{M} \cdot \partial F / \partial \rho$$

where V : Volume, ρ : Normalized radius, $V' = dV/d\rho$

- **Particle transport**

$$\frac{1}{V'} \frac{\partial}{\partial t} (n_s V') = - \frac{\partial}{\partial \rho} \left(V' \langle |\nabla \rho| \rangle n_s V_s - V' \langle |\nabla \rho|^2 \rangle D_s \frac{\partial n_s}{\partial \rho} \right) + S_s$$

- **Toroidal momentum transport**

$$\frac{1}{V'} \frac{\partial}{\partial t} (n_s u_{\phi_s} V') = - \frac{\partial}{\partial \rho} \left(V' \langle |\nabla \rho| \rangle n_s u_{\phi_s} V_{Ms} - V' \langle |\nabla \rho|^2 \rangle n_s \mu_s \frac{\partial u_{\phi_s}}{\partial \rho} \right) + M_s$$

- **Heat transport**

$$\frac{1}{V'^{5/3}} \frac{\partial}{\partial t} \left(\frac{3}{2} n_s T_s V'^{5/3} \right) = - \frac{1}{V'} \frac{\partial}{\partial \rho} \left(V' \langle |\nabla \rho| \rangle \frac{3}{2} n_s T_s V_{Es} - V' \langle |\nabla \rho|^2 \rangle n_s \chi_s \frac{\partial T_s}{\partial \rho} \right) + P_s$$

- **Current diffusion**

$$\frac{\partial B_\theta}{\partial t} = \frac{\partial}{\partial \rho} \left[\frac{\eta}{FR_0 \langle R^{-2} \rangle \mu_0} \frac{R_0 F^2}{V'} \frac{\partial}{\partial \rho} \left(\frac{V' B_\theta}{F} \left\langle \frac{|\nabla \rho|^2}{R^2} \right\rangle \right) - \frac{\eta}{FR_0 \langle R^{-2} \rangle} \langle \mathbf{J} \cdot \mathbf{B} \rangle_{\text{ext}} \right]$$

Transport Processes

- **Neoclassical transport**
 - Collisional transport in an inhomogeneous magnetic field
 - **Radial diffusion**: usually small compared with turbulent diffusion
 - **Enhanced resistivity**: due to trapped particles
 - **Bootstrap current**: toroidal current driven by radial pressure gradient
 - **Ware pinch**: Radial particle pinch driven by toroidal electric field
- **Turbulent transport**
 - Various transport models: **GLF23**, **CDBM**, **Weiland**, ...
- **Atomic transport**: charge exchange, ionization, recombination
- **Radiation transport**
 - Line radiation, Bremsstrahlung, Synchrotron radiation
- **Parallel transport**: along open magnetic field lines in **SOL plasmas**

Turbulent Transport Models

- **CDBM model**: current diffusive ballooning mode turbulence model
 - **developed by K. Itoh et al.**
 - Marginal stability condition of the current diffusive ballooning mode including turbulent transport coefficients as parameters
- **GLF23 model**: Gyro-Landau-Fluid turbulence model
 - **developed by Waltz and Kinsey (GA)**
 - Linear growth rate from gyro-Landau-fluid model (ITG, TEM, ETG)
 - Evaluate transport coefficients based on mixing length estimate
 - Calibrate coefficients by the linear stability code GKS
 - Calibrate coefficients by the nonlinear turbulence code GYRO
- **Weiland model**:
 - **developed by J. Weiland**
 - Based on ITG turbulence model

GLF23 Transport Model

Linear growth rate from gyro-Landau-fluid model

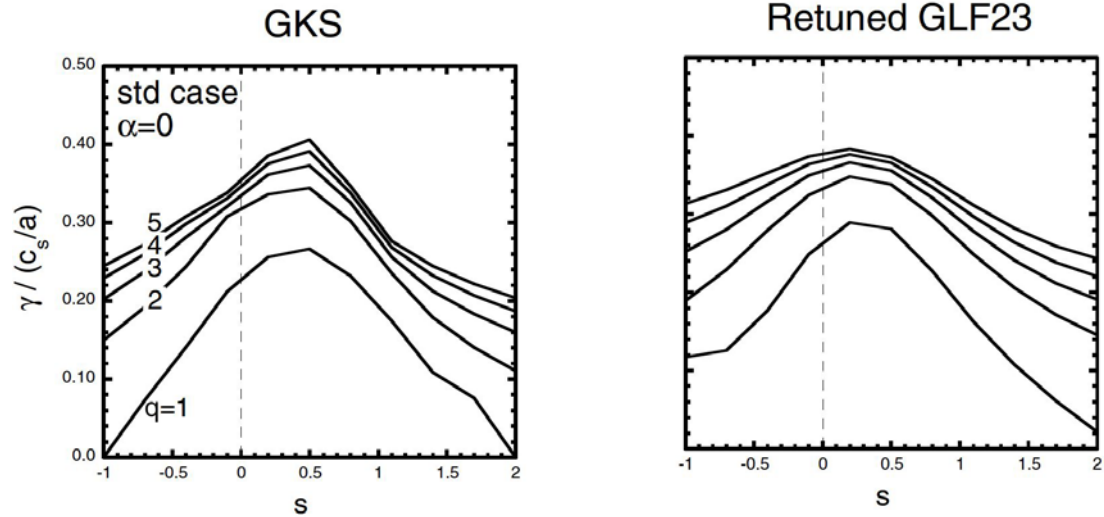

Calibrate coefficients by the nonlinear turbulence code GYRO

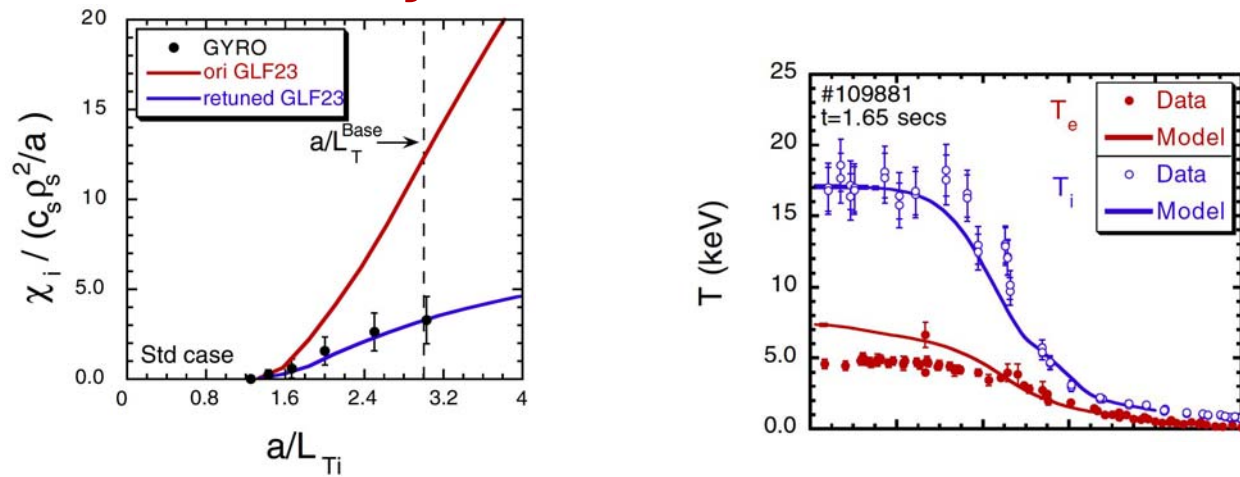

Good agreement with experimental data

CDBM Transport Model: CDBM05

- Thermal Diffusivity** (Marginal: $\gamma = 0$)

$$\chi_{\text{TB}} = F(s, \alpha, \kappa, \omega_{E1}) \alpha^{3/2} \frac{c^2}{\omega_{pe}^2} \frac{v_A}{qR}$$

Magnetic shear $s \equiv \frac{r}{q} \frac{dq}{dr}$

Pressure gradient $\alpha \equiv -q^2 R \frac{d\beta}{dr}$

Elongation $\kappa \equiv b/a$

$E \times B$ rotation shear $\omega_{E1} \equiv \frac{r^2}{sv_A} \frac{d}{dr} \frac{E}{rB}$

- Weak and negative magnetic shear, Shafranov shift, elongation, and $E \times B$ rotation shear reduce thermal diffusivity.**

$s - \alpha$ dependence of $F(s, \alpha, \kappa, \omega_{E1})$

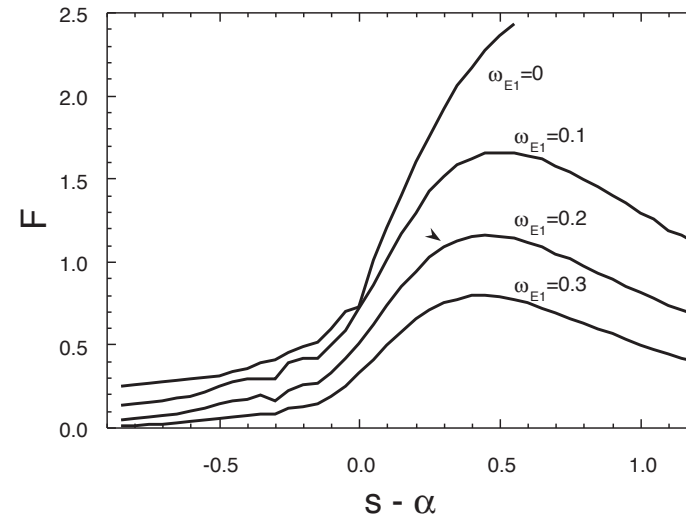

$$F(s, \alpha, \kappa, \omega_{E1}) = \left(\frac{2\kappa^{1/2}}{1 + \kappa^2} \right)^{3/2}$$

$$\times \left\{ \begin{array}{l} \frac{1}{1 + G_1 \omega_{E1}^2} \frac{1}{\sqrt{2(1 - 2s')(1 - 2s' + 3s'^2)}} \\ \text{for } s' = s - \alpha < 0 \\ \\ \frac{1}{1 + G_1 \omega_{E1}^2} \frac{1 + 9\sqrt{2}s'^{5/2}}{\sqrt{2(1 - 2s' + 3s'^2 + 2s'^3)}} \\ \text{for } s' = s - \alpha > 0 \end{array} \right.$$

TFTR #88615 (L-mode, NBI heating)

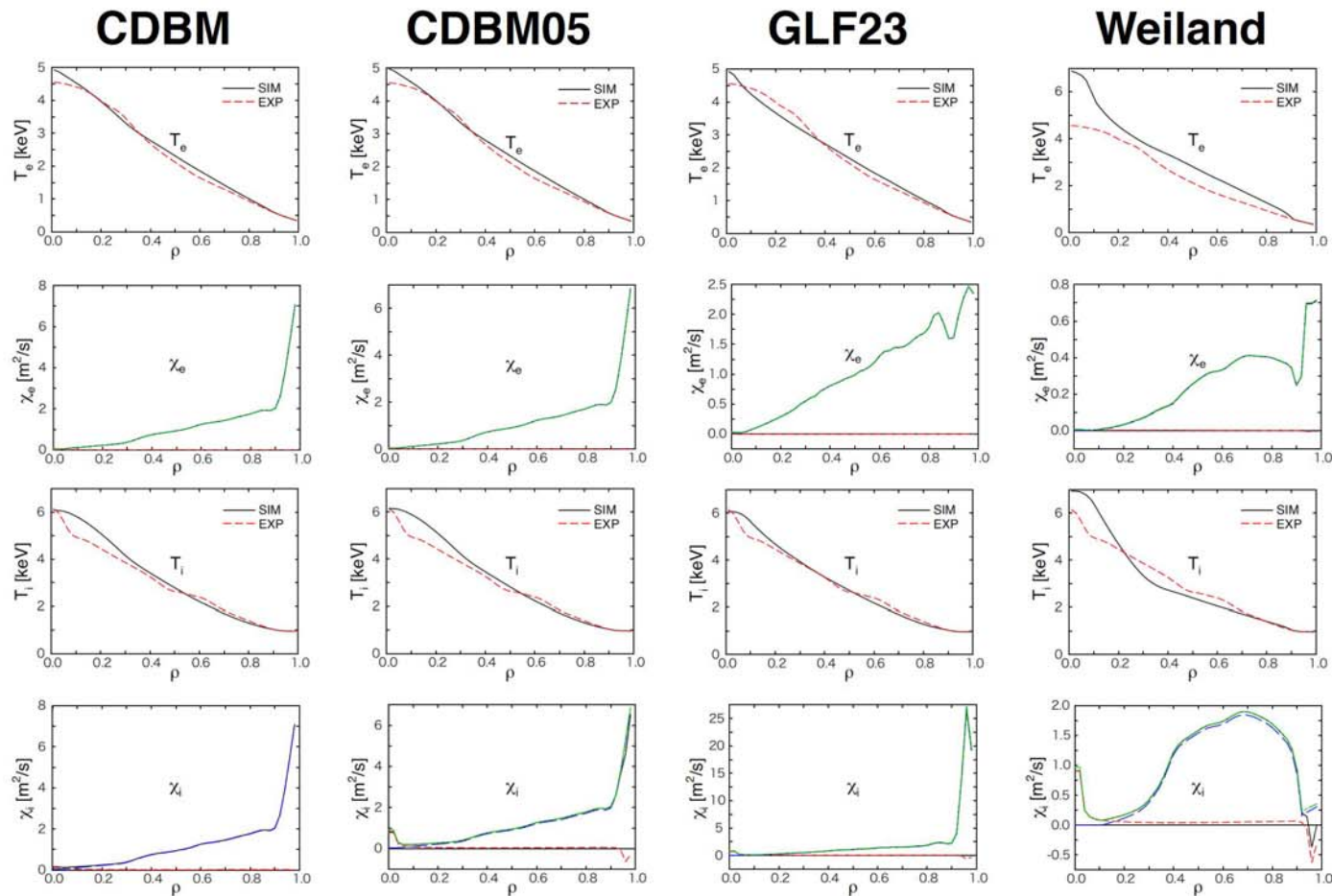

Common Profiles

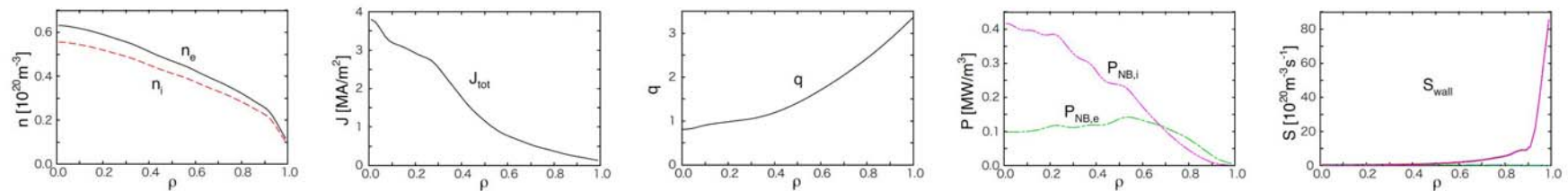

DIII-D #78316 (L-mode, ECH and ICH heatings)

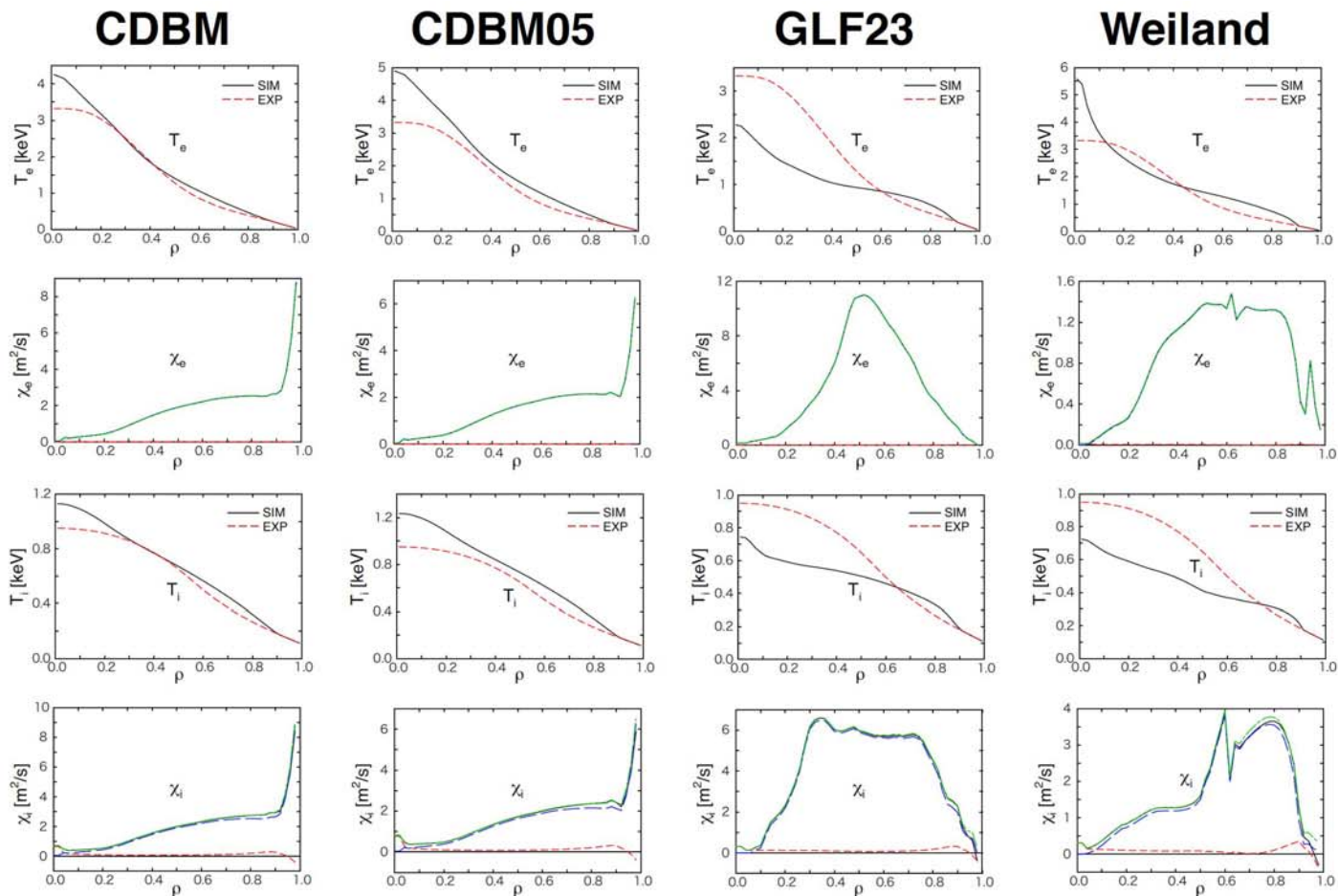

Common Profiles

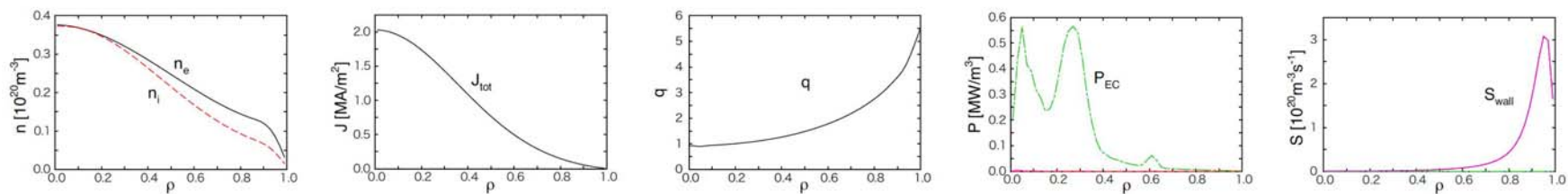

Comparison of Transport Models: ITPA Profile DB

Deviation of Stored Energy

CDBM

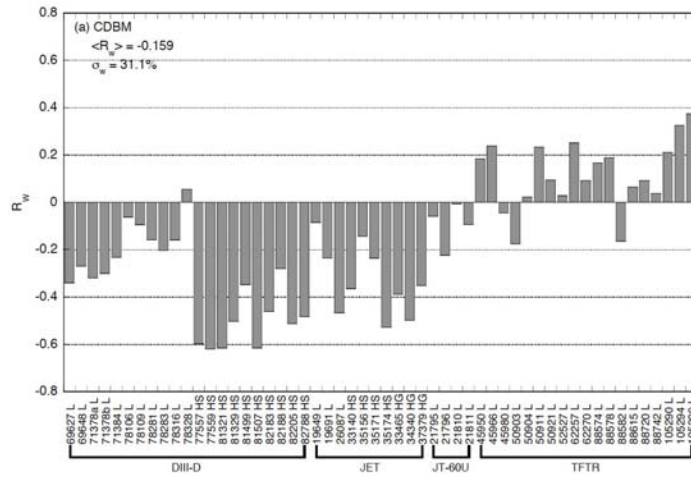

CDBM05

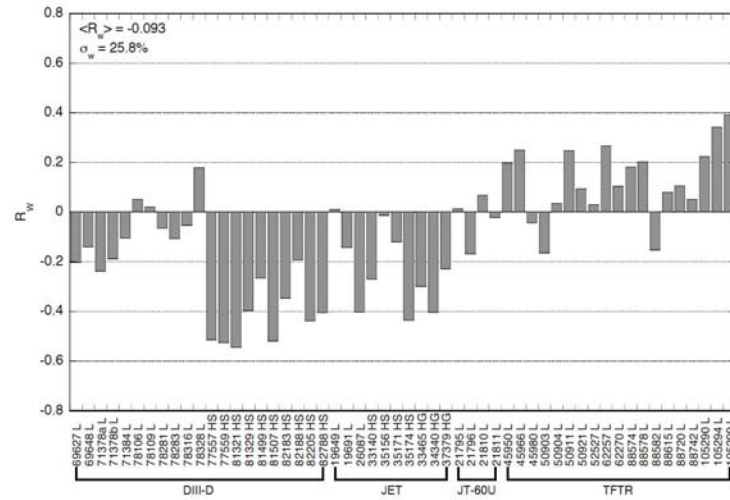

GLF23

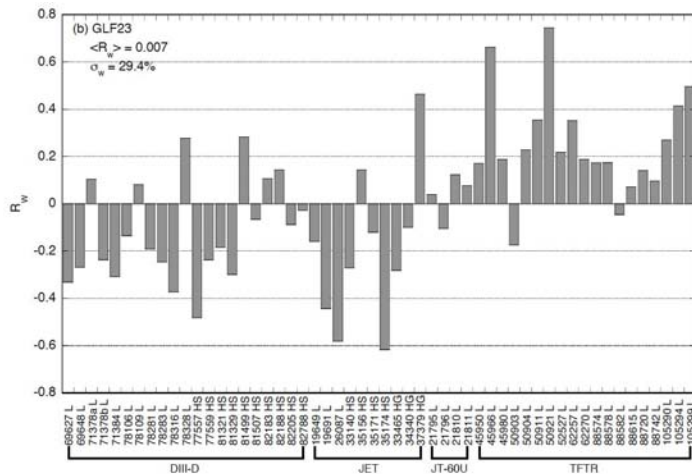

Weiland

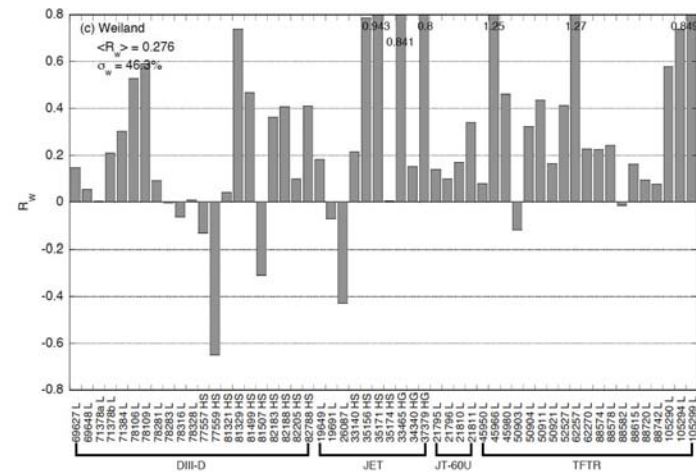

1D Dynamic Transport Code: TASK/TX

- **Dynamic Transport Equations** (TASK/TX)
 - M. Honda and A. Fukuyama, JCP 227 (2008) 2808*
 - **A set of flux-surface averaged equations**
 - **Two fluid equations for electrons and ions**
 - Continuity equations
 - Equations of motion (radial, poloidal and toroidal)
 - Energy transport equations
 - **Maxwell's equations**
 - **Slowing-down equations for beam ion component**
 - **Diffusion equations for two-group neutrals**
- **Self-consistent description of plasma rotation and electric field**
 - Equation of motion rather than transport matrix
- **Quasi-neutrality is not assumed.**

Model Equation of Dynamic Transport Simulation

- Flux-surface-averaged multi-fluid equations:**

$$\frac{\partial n_s}{\partial t} = -\frac{1}{r} \frac{\partial}{\partial r} (r n_s u_{sr}) + S_s$$

$$\frac{\partial}{\partial t} (m_s n_s u_{sr}) = -\frac{1}{r} \frac{\partial}{\partial r} (r m_s n_s u_{sr}^2) + \frac{1}{r} m_s n_s u_{s\theta}^2 + e_s n_s (E_r + u_{s\theta} B_\phi - u_{s\phi} B_\theta) - \frac{\partial}{\partial r} n_s T_s$$

$$\begin{aligned} \frac{\partial}{\partial t} (m_s n_s u_{s\theta}) &= -\frac{1}{r^2} \frac{\partial}{\partial r} (r^2 m_s n_s u_{sr} u_{s\theta}) + e_s n_s (E_\theta - u_{sr} B_\phi) + \frac{1}{r^2} \frac{\partial}{\partial r} \left(r^3 n_s m_s \mu_s \frac{\partial u_{s\theta}}{\partial r} \frac{1}{r} \right) \\ &\quad + F_{s\theta}^{\text{NC}} + F_{s\theta}^{\text{C}} + F_{s\theta}^{\text{W}} + F_{s\theta}^{\text{X}} + F_{s\theta}^{\text{L}} \end{aligned}$$

$$\begin{aligned} \frac{\partial}{\partial t} (m_s n_s u_{s\phi}) &= -\frac{1}{r} \frac{\partial}{\partial r} (r m_s n_s u_{sr} u_{s\phi}) + e_s n_s (E_\phi + u_{sr} B_\theta) + \frac{1}{r} \frac{\partial}{\partial r} \left(r n_s m_s \mu_s \frac{\partial u_{s\phi}}{\partial r} \right) \\ &\quad + F_{s\phi}^{\text{C}} + F_{s\phi}^{\text{W}} + F_{s\phi}^{\text{X}} + F_{s\phi}^{\text{L}} \end{aligned}$$

$$\begin{aligned} \frac{\partial}{\partial t} \frac{3}{2} n_s T_s &= -\frac{1}{r} \frac{\partial}{\partial r} r \left(\frac{5}{2} u_{sr} n_s T_s - n_s \chi_s \frac{\partial T_e}{\partial r} \right) + e_s n_s (E_\theta u_{s\theta} + E_\phi u_{s\phi}) \\ &\quad + P_s^{\text{C}} + P_s^{\text{L}} + P_s^{\text{H}} \end{aligned}$$

Typical Ohmic Plasma Profiles at $t = 50$ ms

JFT-2M like plasma composed of electron and hydrogen

$R = 1.3$ m, $a = 0.35$ m, $b = 0.4$ m, $B_{\phi b} = 1.3$ T, $I_p = 0.2$ MA, $S_{\text{puff}} = 5.0 \times 10^{18} \text{ m}^{-2} \text{ s}^{-1}$
 $\gamma = 0.8$, $Z_{\text{eff}} = 2.0$, Fixed turbulent coefficient profile

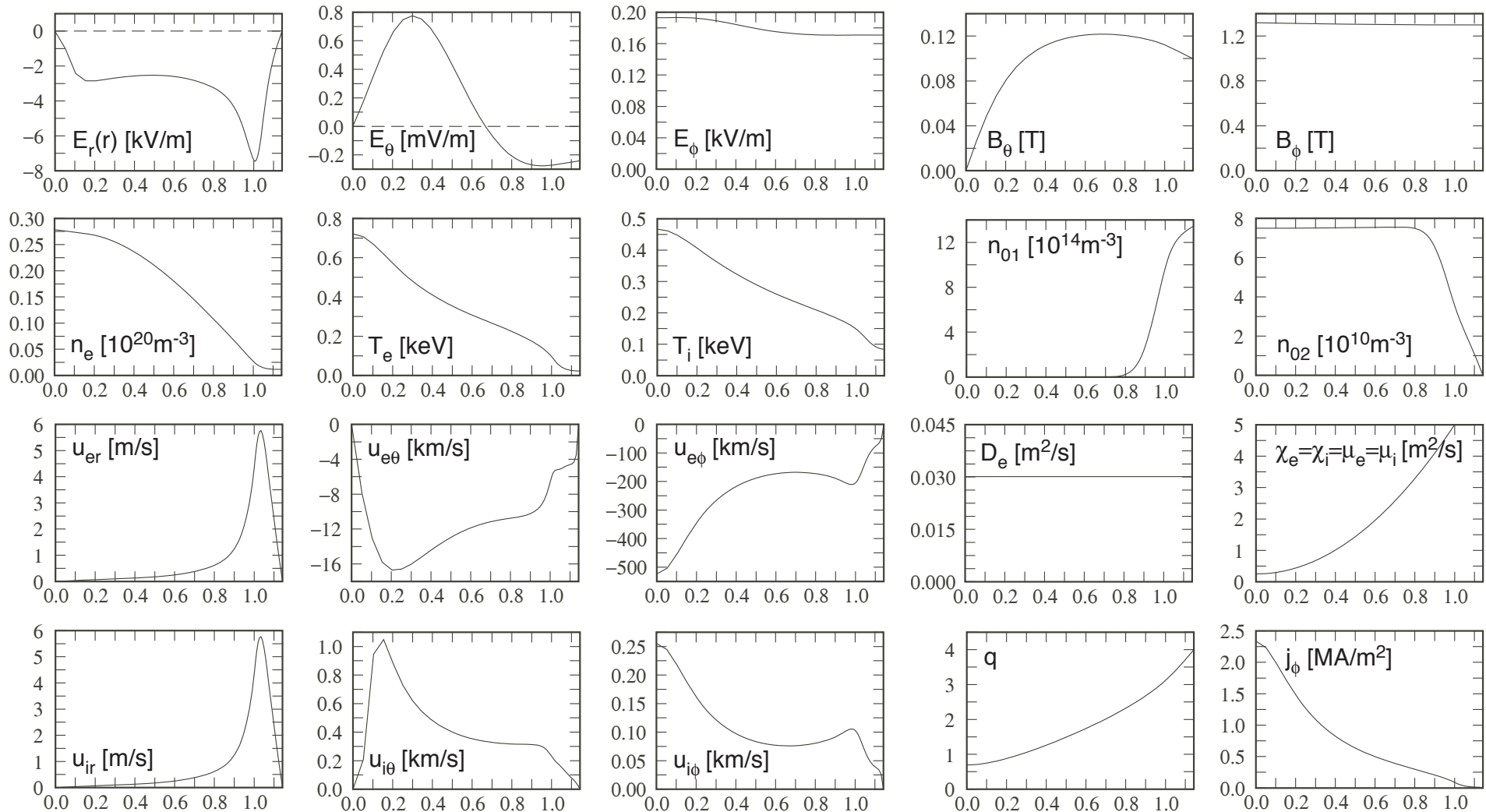

Density Profile Modification Due to NBI Injection

Modification of n and E_r profile depends on the direction of NBI.

Co/Counter with I_p : Density flattening/peaking

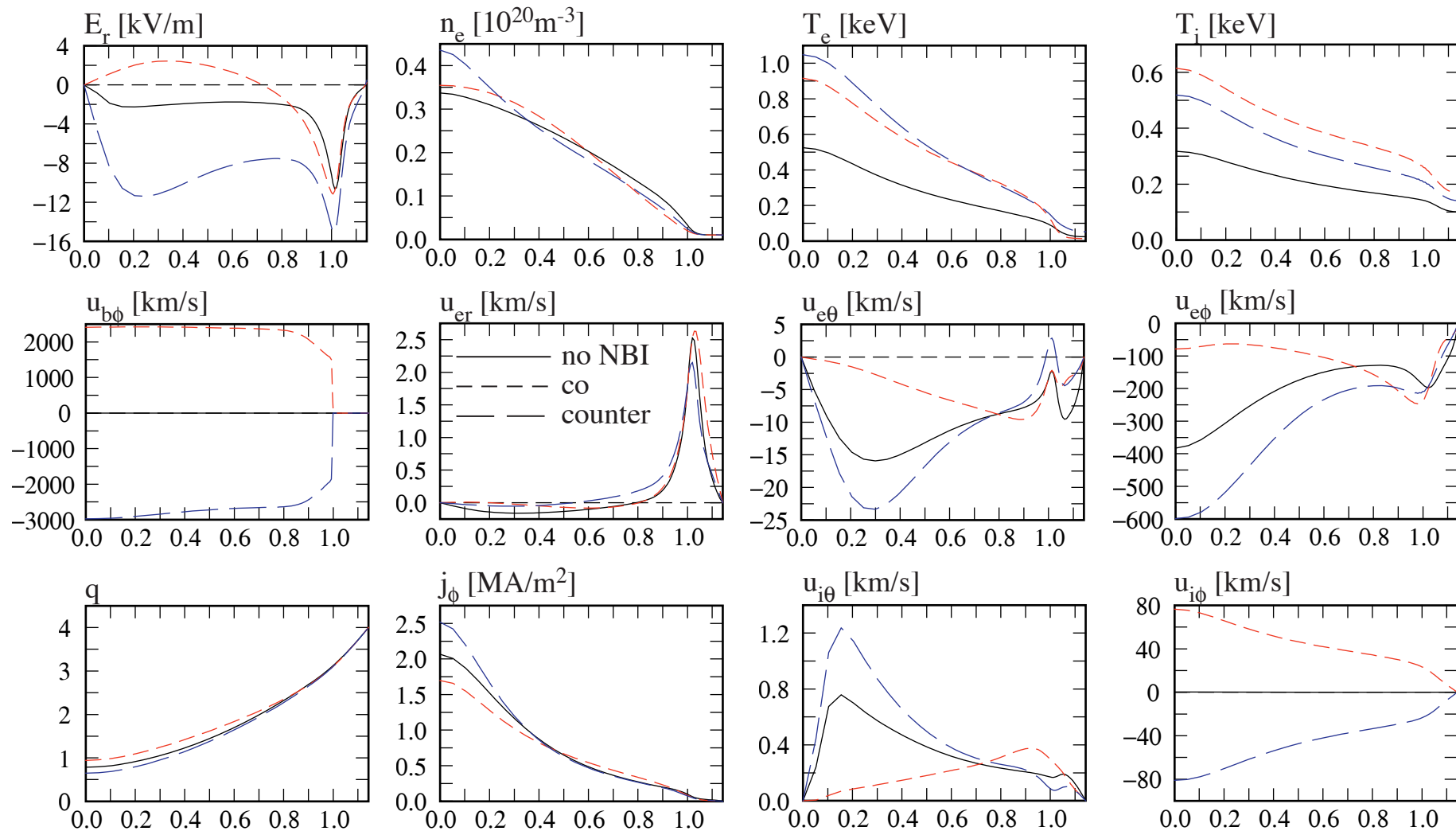

Toroidal Rotation Due to Ion Orbit Loss

- Ion orbit loss near the edge region drives toroidal rotation

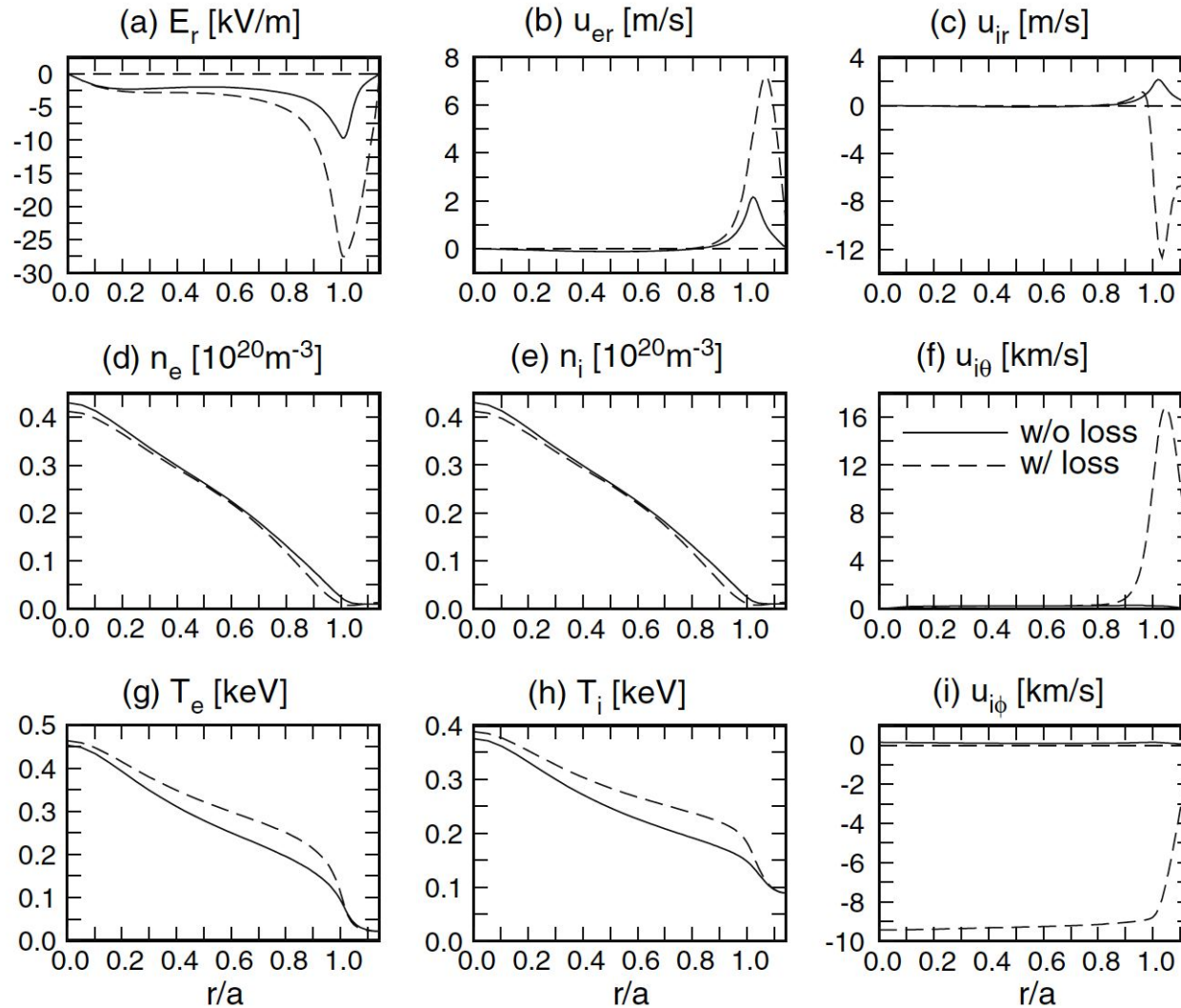

Ref. M. Honda et al., NF (2008) 085003

Source Modeling

- **Heat and momentum sources:**
 - **Alpha particle heating:**
 - sensitive to fuel density and momentum distribution
 - **Neutral beam injection:**
 - birth profile, finite size orbit, deposition to bulk plasma
 - **Waves:**
 - **IC** (~ 50 MHz): fuel ion heating, current drive, rotation drive(?)
 - **LH** (~ 10 GHz): current drive
 - **EC** (~ 170 GHz): current drive, pre-ionization
- **Particle source**
 - **Gas puff, recycling:**
 - **Neutral beam injection:**
 - **Pellet injection:** penetration, evaporation, ionization, drift motion

Wave Modeling

- **Ray tracing:** EC, LH
 - Spatial evolution of ray position and wave number
 - Wave length λ much less than scale length L : $\lambda \ll L$
 - Beam size d is sufficiently large (**Fresnel condition**): $L \ll d^2/\lambda$
- **Beam tracing:** EC
 - New variables: beam radius, curvature of equi-phase surface
- **Beam propagation:** EC
 - Under development: Time evolution of $\mathbf{E}(\mathbf{r}, t) e^{i\omega t}$
- **Full wave analysis:** IC, AW, MHD
 - Stationary Maxwell's equation as a boundary problem
 - Wave length λ comparable with scale length L
 - Evanescent region, strong absorption, coupling with antenna

Wave Dispersion Analysis : TASK/DP

- **Various Models of Dielectric Tensor $\overleftrightarrow{\epsilon}(\omega, k; r)$:**
- **Analytic model**
 - Resistive MHD model
 - Collisional cold plasma model
 - Collisional warm plasma model
 - Kinetic model (Maxwellian, non-relativistic)
 - Drift-kinetic model (Maxwellian, inhomogeneity)
 - **Hamiltonian formulation (cyclotron, bounce, precession)**
- **Numerical integration**
 - Kinetic model (Relativistic, Maxwellian)
 - Kinetic model (Relativistic, arbitrary $f(v)$)
 - **Drift-kinetic model (Inhomogeneity, arbitrary $f(v)$)**
 - **Hamiltonian formulation (arbitrary $f(v)$)**

Ray Tracing: TASK/WR

- **Geometrical Optics**

- Wave length $\lambda \ll$ Characteristic scale length L of the medium
- Plane wave: Beam size d is sufficiently large
 - **Fresnel condition is well satisfied:** $L \ll d^2/\lambda$

- **Evolution along the ray trajectory τ**

- Wave packet position \mathbf{r} , wave number \mathbf{k} , dielectric tensor K
- **Ray tracing equation:**

$$\frac{d\mathbf{r}}{d\tau} = \frac{\partial K}{\partial \mathbf{k}} / \frac{\partial K}{\partial \omega}$$

$$\frac{d\mathbf{k}}{d\tau} = - \frac{\partial K}{\partial \mathbf{r}} / \frac{\partial K}{\partial \omega}$$

- **Equation for wave energy** W , group velocity \mathbf{v}_g , damping rate γ

$$\nabla \cdot (\mathbf{v}_g W) = -2\gamma W$$

Beam Tracing: TASK/WR

- Beam size perpendicular to the beam direction: first order in ϵ
- **Beam shape** : Hermite polynomial: H_n)

$$E(\mathbf{r}) = \text{Re} \left[\sum_{mn} C_{mn}(\epsilon^2 \mathbf{r}) \mathbf{e}(\epsilon^2 \mathbf{r}) H_m(\epsilon \xi_1) H_n(\epsilon \xi_2) e^{i s(\mathbf{r}) - \phi(\mathbf{r})} \right]$$

– Amplitude : C_{mn} , Polarization : \mathbf{e} , Phase : $s(\mathbf{r}) + i \phi(\mathbf{r})$

$$s(\mathbf{r}) = s_0(\tau) + k_\alpha^0(\tau)[r^\alpha - r_0^\alpha(\tau)] + \frac{1}{2} s_{\alpha\beta}[r^\alpha - r_0^\alpha(\tau)][r^\beta - r_0^\beta(\tau)]$$

$$\phi(\tau) = \frac{1}{2} \phi_{\alpha\beta}[r^\alpha - r_0^\alpha(\tau)][r^\beta - r_0^\beta(\tau)]$$

– Position of beam axis : r_0 , Wave number on beam axis: k^0

– **Curvature radius** of equi-phase surface: $R_\alpha = 1/\lambda s_{\alpha\alpha}$

– **Beam radius**: $d_\alpha = \sqrt{2/\phi_{\alpha\alpha}}$

- Gaussian beam : case with $m = 0, n = 0$

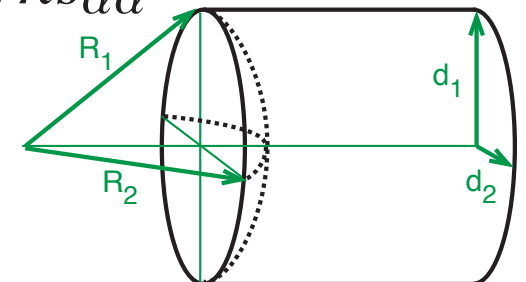

Beam Propagation Equation

- Solvable condition for Maxwell's equation with beam field**

$$\frac{dr_0^\alpha}{d\tau} = \frac{\partial K}{\partial k_\alpha}$$

$$\frac{dk_\alpha^0}{d\tau} = -\frac{\partial K}{\partial r^\alpha}$$

$$\frac{ds_{\alpha\beta}}{d\tau} = -\frac{\partial^2 K}{\partial r^\alpha \partial r^\beta} - \frac{\partial^2 K}{\partial r^\beta \partial k_\gamma} s_{\alpha\gamma} - \frac{\partial^2 K}{\partial r^\alpha \partial k_\gamma} s_{\beta\gamma} - \frac{\partial^2 K}{\partial k_\gamma \partial k_\delta} s_{\alpha\gamma} s_{\beta\delta} + \frac{\partial^2 K}{\partial k_\gamma \partial k_\delta} \phi_{\alpha\gamma} \phi_{\beta\delta}$$

$$\frac{d\phi_{\alpha\beta}}{d\tau} = -\left(\frac{\partial^2 K}{\partial r^\alpha \partial k_\gamma} + \frac{\partial^2 K}{\partial k_\gamma \partial k_\delta} s_{\alpha\delta}\right) \phi_{\beta\gamma} - \left(\frac{\partial^2 K}{\partial r^\beta \partial k_\gamma} + \frac{\partial^2 K}{\partial k_\gamma \partial k_\delta} s_{\beta\delta}\right) \phi_{\alpha\gamma}$$

- By integrating this set of 18 ordinary differential equations, we obtain trace of the beam axis, wave number on the beam axis, curvature of equi-phase surface, and beam size.
- Equation for the wave amplitude** C_{mn}

$$\nabla \cdot (\mathbf{v}_{g0} |C_{mn}|^2) = -2(\gamma |C_{mn}|^2)$$

Group velocity: \mathbf{v}_{g0} , Damping rate: $\gamma \equiv (\mathbf{e}^* \cdot \overleftarrow{\epsilon}_A \cdot \mathbf{e}) / (\partial K / \partial \omega)$

Full wave analysis: TASK/WM

- **magnetic surface coordinate:** (ψ, θ, φ)

- Boundary-value problem of **Maxwell's equation**

$$\nabla \times \nabla \times \mathbf{E} = \frac{\omega^2}{c^2} \overleftrightarrow{\epsilon} \cdot \mathbf{E} + i \omega \mu_0 \mathbf{j}_{\text{ext}}$$

- Kinetic **dielectric tensor:** $\overleftrightarrow{\epsilon}$

- **Wave-particle resonance:** $Z[(\omega - n\omega_c)/k_{\parallel}v_{\text{th}}]$

- **Fast ion: Drift-kinetic**

$$\left[\frac{\partial}{\partial t} + v_{\parallel} \nabla_{\parallel} + (\mathbf{v}_d + \mathbf{v}_E) \cdot \nabla + \frac{e_{\alpha}}{m_{\alpha}} (v_{\parallel} E_{\parallel} + \mathbf{v}_d \cdot \mathbf{E}) \frac{\partial}{\partial \mathcal{E}} \right] f_{\alpha} = 0$$

- Poloidal and toroidal **mode expansion**

- **Accurate estimation of k_{\parallel}**

- Eigenmode analysis: **Complex eigen frequency** which maximize wave amplitude for fixed excitation proportional to electron density

Fokker-Planck Analysis : TASK/FP

- **Fokker-Planck equation**

for **multi-species velocity distribution function**: $f_s(p_{\parallel}, p_{\perp}, \psi, t)$

$$\frac{\partial f_s}{\partial t} = E(f_s) + C(f_s) + Q(f_s) + L(f_s)$$

- $E(f)$: Acceleration term due to DC electric field
 - $C(f)$: Coulomb collision term
 - $Q(f)$: Quasi-linear term due to wave-particle resonance
 - $L(f)$: Spatial diffusion term
- **Bounce-averaged**: Trapped particle effect, zero banana width
 - **Relativistic**: momentum p , weakly relativistic collision term
 - **Nonlinear collision**: momentum and energy conservation
 - **Multi-species**: conservation between species
 - **Three-dimensional**: spatial diffusion (neoclassical, turbulent)

ITER Modeling Needs

based on Dr. Campbell' talk at Cadarache, Sept 2007

- **Plasma scenario development:**
 - Preparation for operation
- **Detailed design of auxiliary systems:**
 - H&CD, Diagnostics, Fueling, . . .
- **Design of plasma control system:**
 - Development and optimization of integrated control strategies
- **Preparation of ITER operational programme:**
 - End-to-end scenario development
 - Detailed pulse definition
- **Experimental data evaluation:**
 - Pulse characterization and physics analysis
 - Refinement of operation scenario and performance predictions

Analysis of EC propagation in ITER

BB = 5.300 Q0 = 1.000 PA(1) = 0.0005
RR = 6.200 QA = 3.000 PZ(1) = -1.0000
RA = 2.000 RF = 1.700E+05 PN(1) = 0.8000
RKAP = 1.700 NPHII = -0.1177 PNS(1) = 0.0100

PTPR(1) = 20.0000 PA(2) = 2.0000 PTPR(2) = 20.0000
PTPP(1) = 20.0000 PZ(2) = 1.0000 PTPP(2) = 20.0000
PTS(1) = 0.0500 PN(2) = 0.4000 PTS(2) = 0.0500
MODEL1 = 25. PNS(2) = 0.0050 MODEL2 = 1.

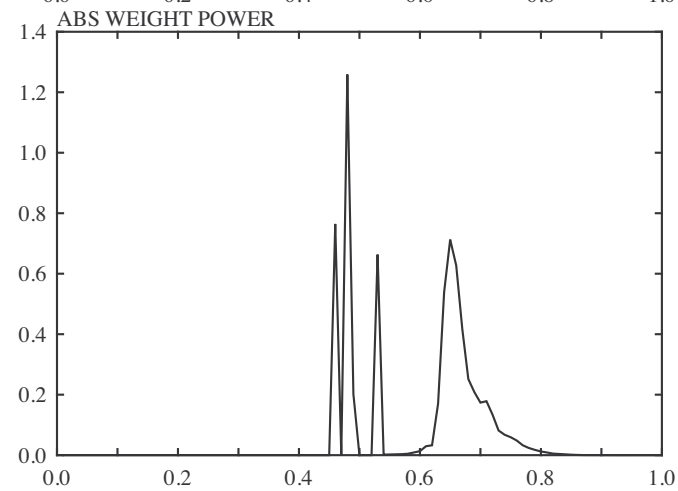
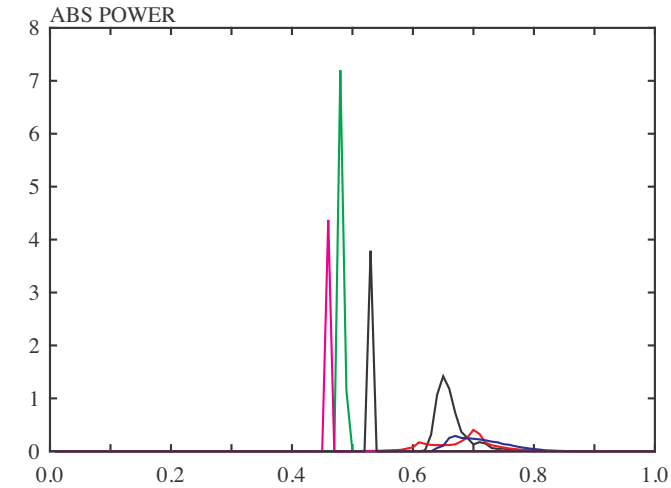
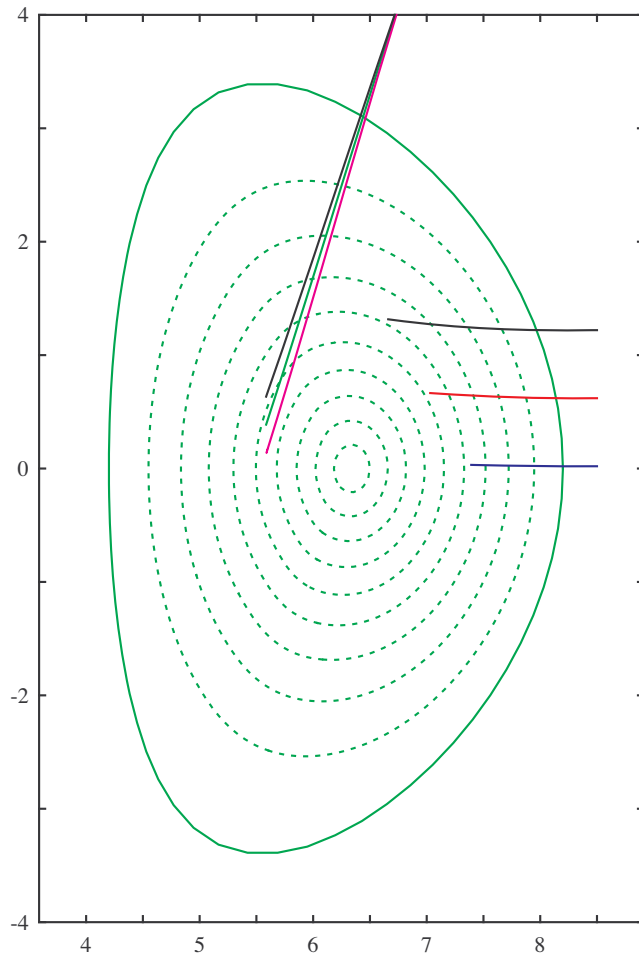

Analysis of IC propagation in ITER

- Minority heating in D phase: D + H

Radial profile

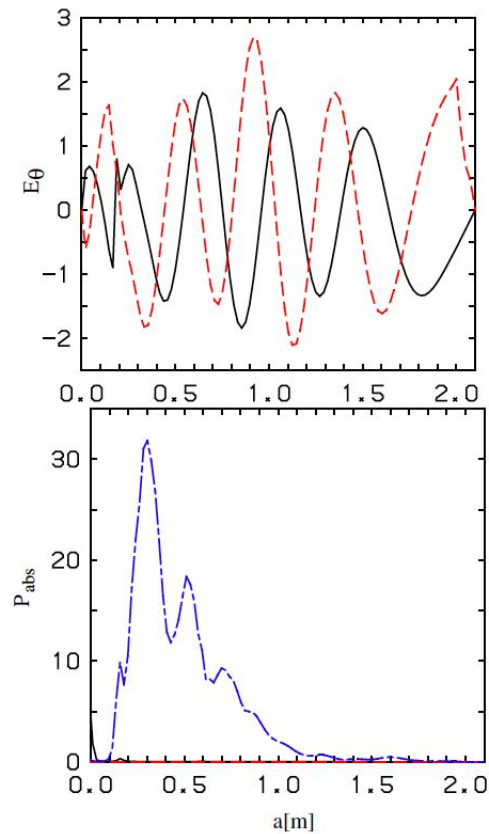

Wave electric field

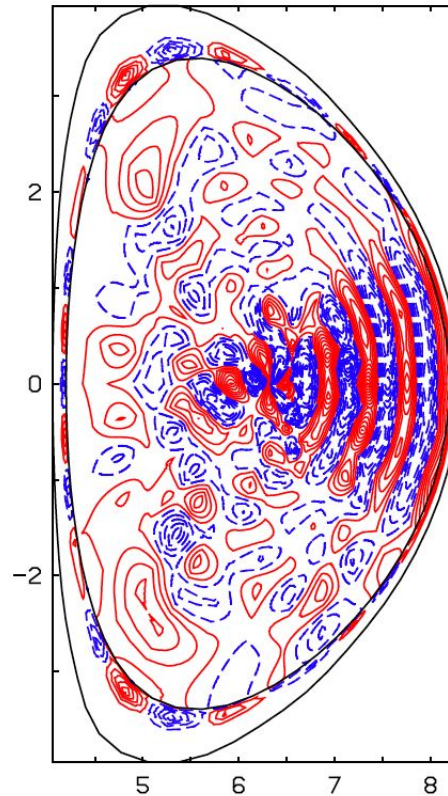

P_{abs} by minority ion

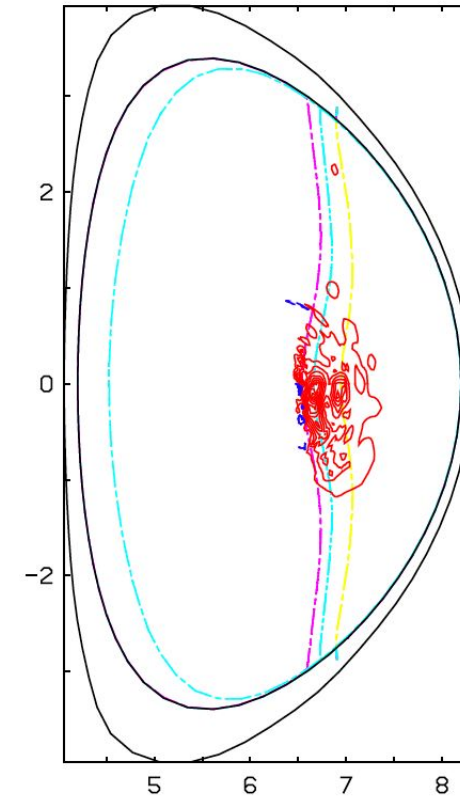

ITER Plasma Transport Simulation with CDBM05

• Inductive operation

- $I_p = 15$ MA
- $P_{NB} = 40$ MW on axis
- $\beta_N = 2.65$

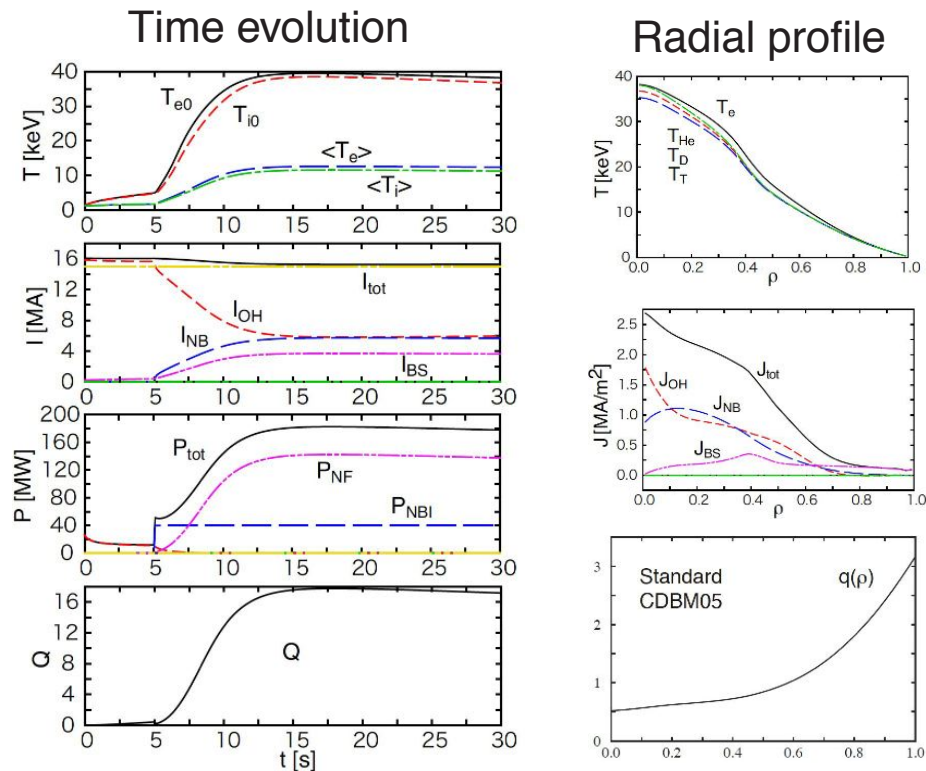

• Hybrid operation

- $I_p = 12$ MA
- $P_{NB} = 33$ MW on axis
- $\beta_N = 2.68$

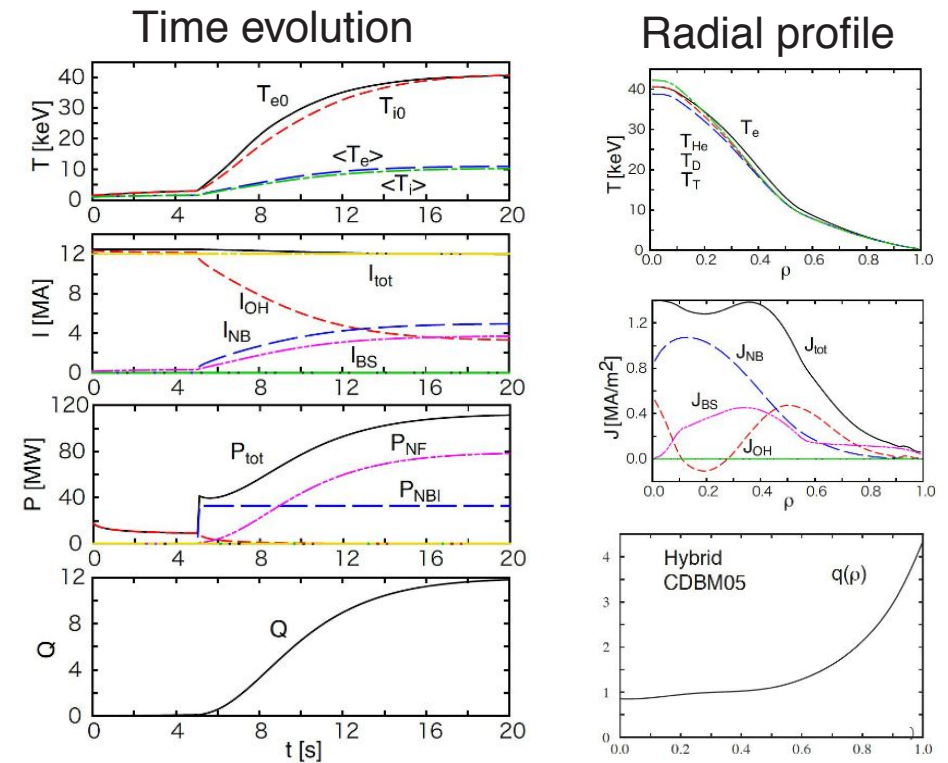

Alfvén Eigenmode Analysis by TASK/WM

- **Alfvén eigenmode driven by alpha particles**
 - Calculated by the full wave module TASK/WM
 - Toroidal mode number: $n = 1$
 - TAE is stable: Eigen mode frequency = (95.95 kHz, -1.95 kHz)

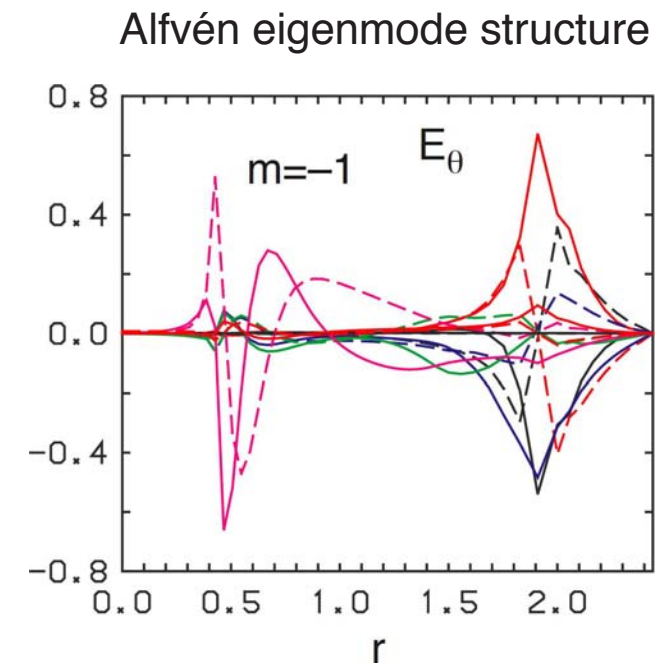
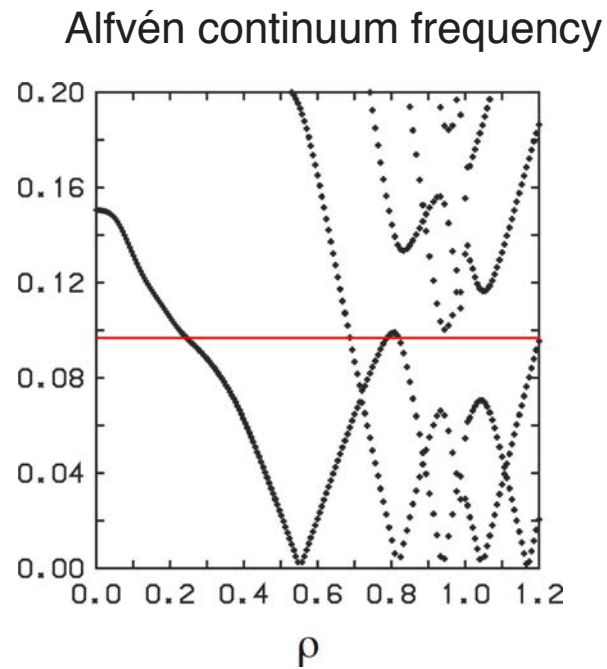
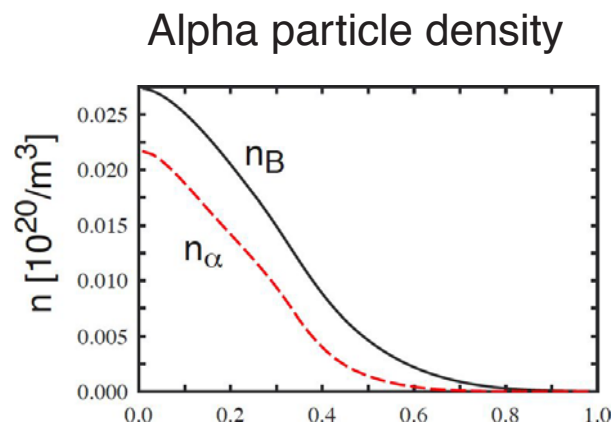

ITER Inductive Operation

- 15 MA Current rise in 70 s

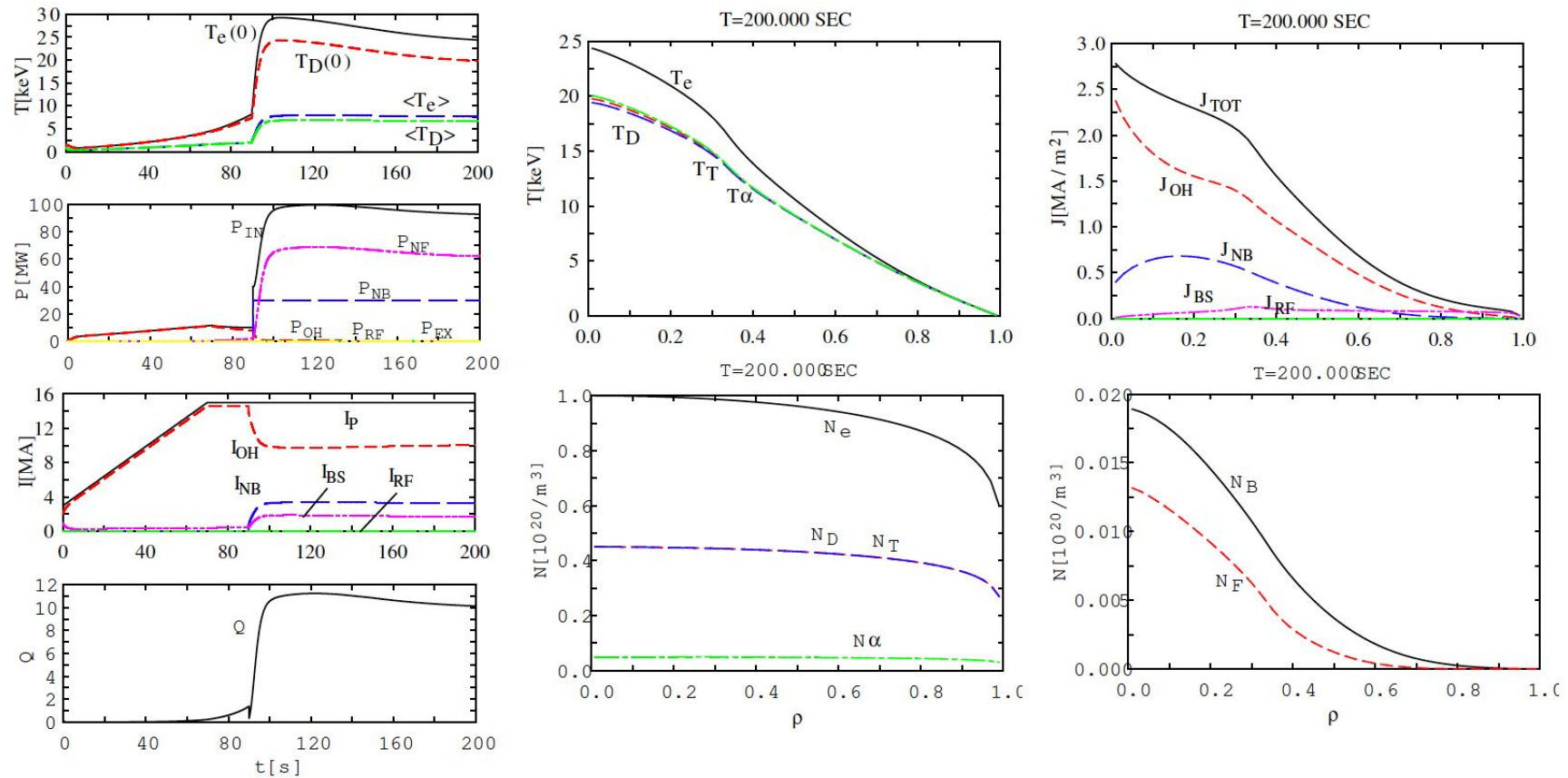

- Behavior of plasma depends on timing of heating

Future Plan of the TASK code

	Present Status	In 2 years	In 5 years
Equilibrium	Fixed/Free Boundary	Equilibrium Evolution	Start Up Analysis
Core Transport	1D Diffusive TR 1D Dynamic TR	Kinetic TR	2D Fluid TR
SOL Transport		2D Fluid TR	Plasma-Wall Interaction
Neutral Transport	1D Diffusive TR	Orbit Following	
Energetic Ions	Kinetic Evolution	Orbit Following	
Wave Beam	Ray/Beam Tracing	Beam Propagation	
Full Wave	Kinetic ϵ	Gyro Integral ϵ	Orbit Integral ϵ
Stabilities	Sawtooth Osc. ELM Model	Tearing Mode Resistive Wall Mode	Systematic Stability Analysis
Turbulent Transport	CDBM Model	Linear GK + ZF	Nonlinear ZK + ZF
		Diagnostic Module	
		Control Module	

Remaining Issues in Tokamak Plasma Modelling

- **Pedestal temperature:** modeling of L/H transition
 - **Transport barrier formation:** turbulence transport model
 - **ELM physics:** nonlinear behavior of ELM on transport
 - **Nonlinear MHD events:** modeling of plasma profile change
 - **Energetic-ion driven phenomena:** coupling of Alfvén mode and drift waves
 - **Kinetic analysis of transport and MHD phenomena:** non-Maxwellian distribution
 - **Wave physics:** full wave analysis of Bernstein waves
 - **Divertor plasma:** plasma-wall interaction
 - **Start up:** Rapid change of equilibrium and control
- and so on...**

Summary

- **Integrated modeling of burning plasmas** is indispensable for exploiting optimized operation scenario of ITER and reliable design of DEMO.
- Discussion on **international collaboration** for the development of **integrated ITER modeling** is on going.
- There are **many remaining issues** in **constructing comprehensive integrated code**; especially, L/H transition mechanism, turbulent transport model, ELM physics, nonlinear MHD events, energetic particle driven phenomena and plasma wall-interactions.
- Solving those remaining issues requires not only **large-scale computer simulations** but also **intensive modeling efforts** based on experimental observations.